

Article number: 203180M850B3SK  
 Description: E+G levelling foot  
 GN 31-80-M8-50-B3-SK  
 Note: SK With nut, External hexagon at the bottom

## Measures

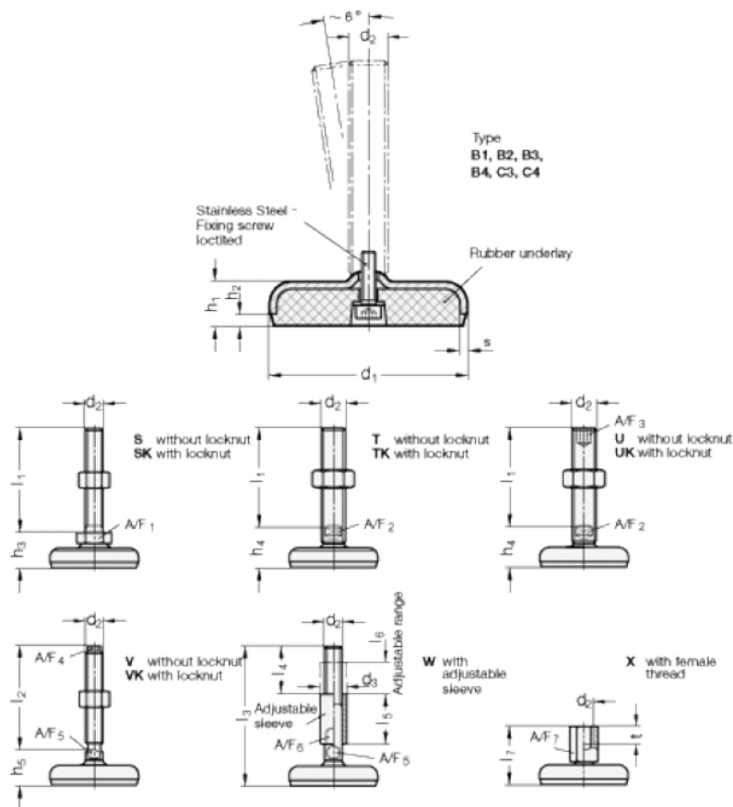

A/F1-	= 17
d1	= 80
d2	= 8
h1	= 18
h2	= 5
h3 +4.0/0	= 26
l1	= 50
s	= 3